

SCHOCK

CRISTADUR®

KYOTO D-100

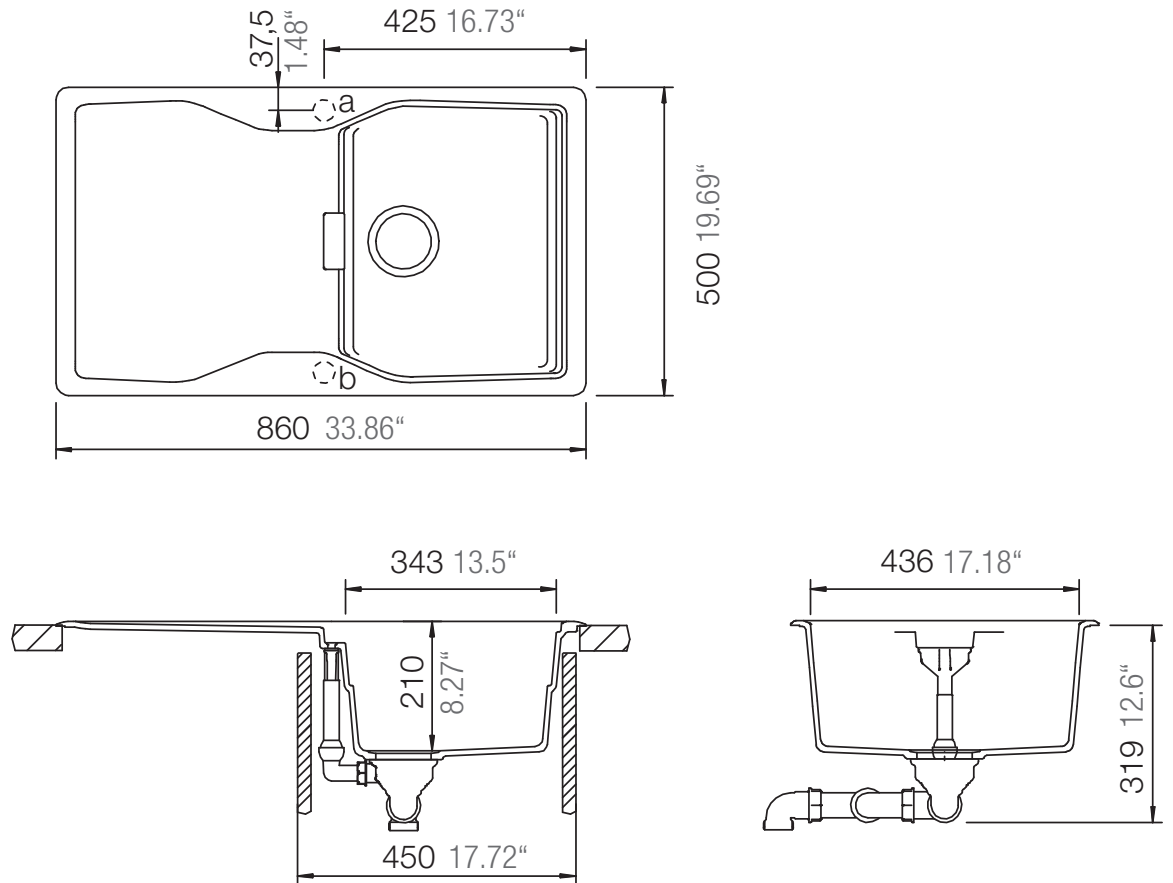

Installation: Von oben / topmount
Ausschnitt / cut-out

